

# MODEL: 5LES7248B1B\*

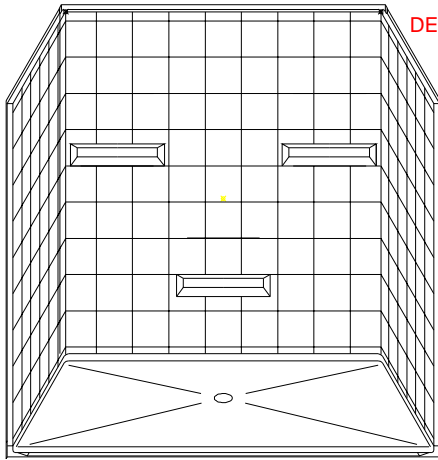

**PERSPECTIVE VIEW - N.T.S.**

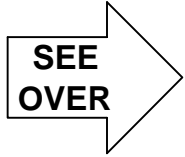
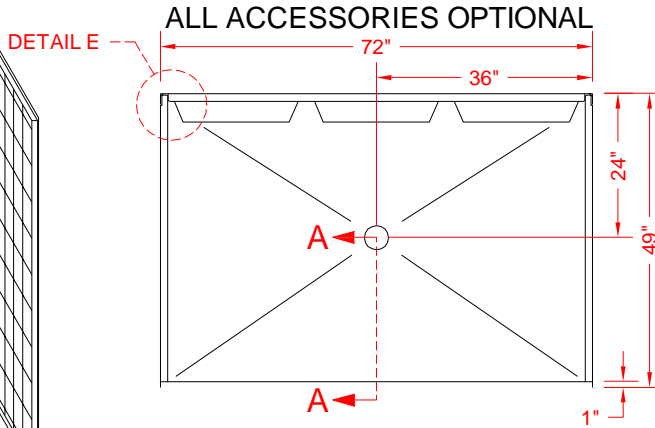

**TOP VIEW - SCALE  $\frac{3}{8}$ " = 1'-0"**

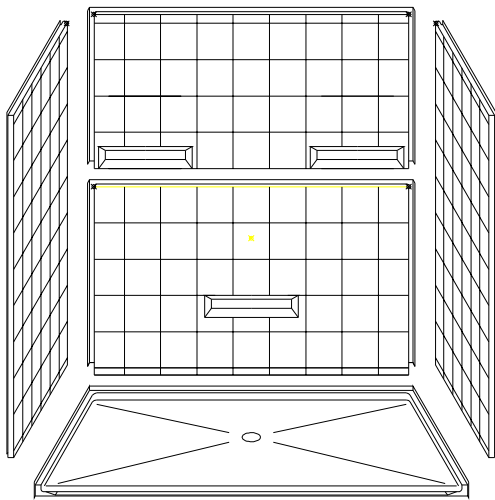

**ASSEMBLY VIEW - N.T.S.**

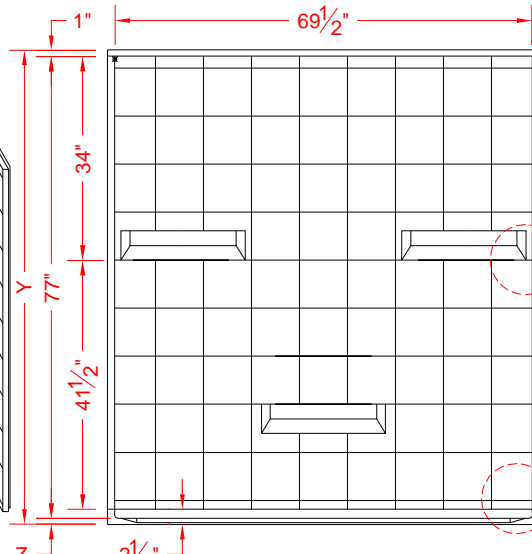

**FRONT ELEVATION - SCALE:  $\frac{3}{8}$ " = 1'-0"**

## Features:

- Molded, 5 piece gelcoat/fiberglass shower module
- Available in various threshold heights
- "Eight inch Tile" wall finish, white (standard)
- Integral full wood backing for strength and unlimited accessory placement
- On all threshold, heights 1-1/2" or taller, no mud set is required
- On all threshold, heights 1-1/4" or shorter, no mud set is required, but an epoxy adhesive kit is supplied

**DETAIL D**

## \*OTHER THRESHOLD HEIGHTS AVAILABLE UPON REQUEST

MODEL #	UNIT HEIGHT	THRESHOLD HEIGHT
5LES7248B1B	Y	Z*
5LES7248B2B	79"	1" MIN.
	81"	2" MAX.

\* - SEE BACK FOR DETAIL SECTIONS

## PRODUCT SPECIFICATIONS:

- Multi piece shower module shall be constructed of gelcoat/fiberglass with full integral plywood backing
- Rough-In: Stud opening +1/4" -0" Nominal Dimensions.

C.S.I. FORMAT SPECIFICATION TEXT AVAILABLE

## PRODUCT INFORMATION:

- Accessories: Factory installed, unless prone to damage during installation/shipping. Polished chrome/satin stainless standard, others available.
- Colors: White as standard, others to match any major fixture manufacturer, also available with sprayable solid surface in many colors
- Custom curb heights, other than shown, are available (between min. and max.)

## ACCESSORIES:

### INSTALLED BY OTHERS:

- Grab bar
- Mixing valve, pressure balanced, lever handle, preplumbed tree to supply elbow
- Curtain and rod
- Collapsible Rubber Water Retainer
- Semi-permanent Threshold Adaptor
- Caulkless drain

## CODES:

- Designed and manufactured in compliance with the following standards and codes:
- A.N.S.I. Z124.2 Standards for Plastic Showers
  - I.P.C. International Plumbing Code
  - U.P.C. Uniform Plumbing Code

## NOTICE OF LIMITATION:



www.orcahealthcare.com  
Tel: 1-855-566-6722



We reserve the right to make revisions without notice in the design of fixtures or in packaging unless this right has specifically been waived at the time the order is accepted.

5LES7248B1B

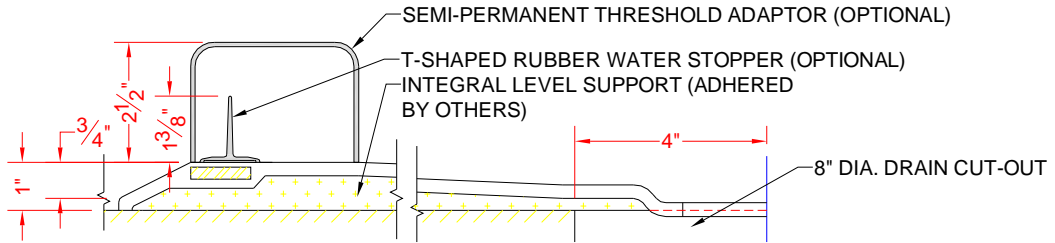

SECTION A-A - SCALE: 3" = 1'-0"

5LES7248B2B

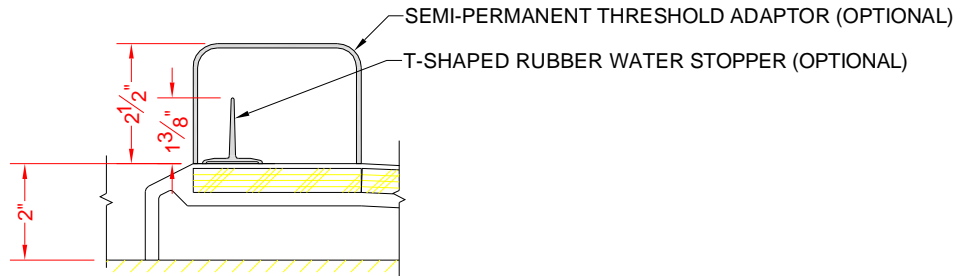

SECTION A-A - SCALE: 3" = 1'-0"

**\*\*OTHER THRESHOLD HEIGHTS AVAILABLE UPON REQUEST\*\***

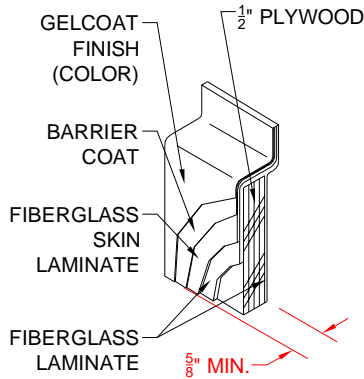

DETAIL B - SCALE: 3" = 1'-0"  
WALL SECTION DETAIL

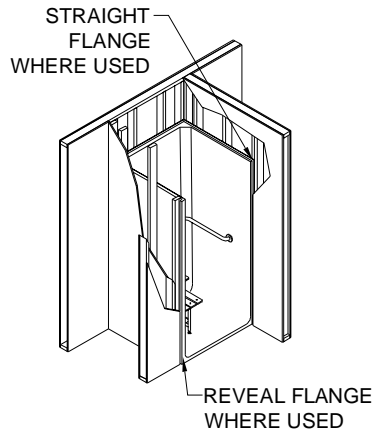

DETAIL C - SCALE: NTS  
TYPICAL FRAMING

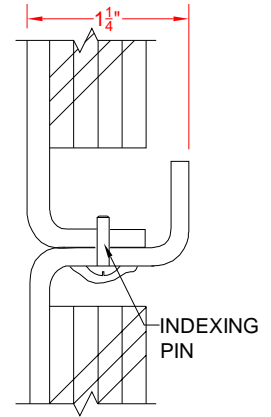

DETAIL D - SCALE: 3" = 1'-0"  
PIN JOINT DETAIL

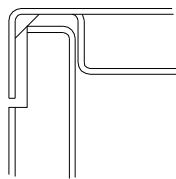

DETAIL E - SCALE: NTS  
WALL JOINT DETAIL

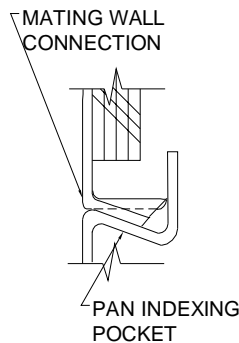

DETAIL F - SCALE: NTS  
PAN JOINT DETAIL

