

MODEL: 5LRS6033

ALL ACCESSORIES OPTIONAL

Remodeler

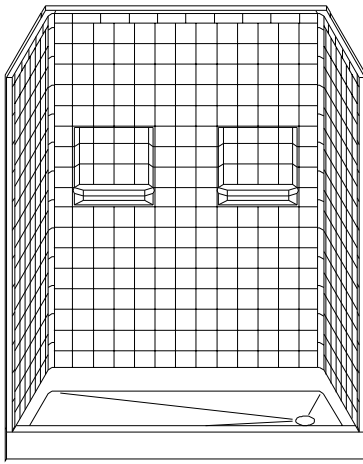

PERSPECTIVE VIEW - N.T.S.

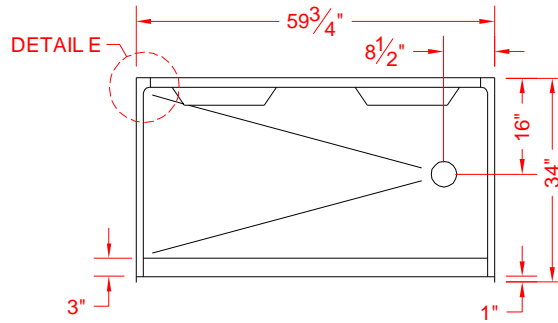

TOP VIEW - SCALE $\frac{3}{8}'' = 1'-0''$

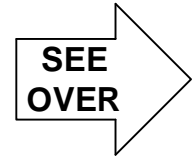

Features:

- Five-piece gelcoat/fiberglass shower module
- Available in Right (shown) and Left Drain
- "RealTile" wall finish, white (standard)
- Integral full wood backing for strength and unlimited accessory placement
- Easy in-place installation from the front
- The authentic look of ceramic tile without the grout

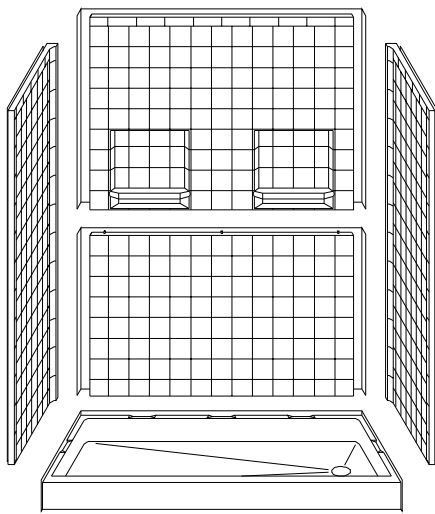

ASSEMBLY VIEW - N.T.S.

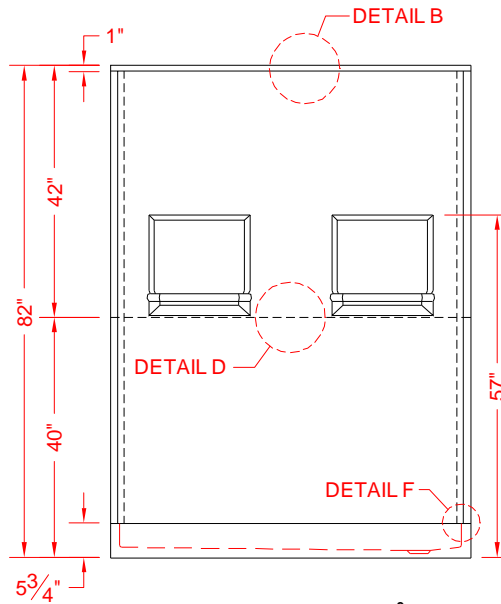

FRONT ELEVATION - SCALE: $\frac{3}{8}'' = 1'-0''$

* - SEE BACK FOR DETAIL SECTIONS

PRODUCT SPECIFICATIONS:

- Multi piece shower module shall be constructed of gelcoat/fiberglass with full integral plywood backing in the walls
- Door opening: 57-3/8" x 75"
- Rough-In: Stud opening +1/4" -0" Nominal Dimensions.
- C.S.I. FORMAT SPECIFICATION TEXT AVAILABLE

PRODUCT INFORMATION:

- Accessories: Polished chrome/satin stainless standard, others available.
- Colors: White as standard, others to match any major fixture manufacturer, also available with sprayable solid surface in many colors

ACCESSORIES:

- INSTALLED BY OTHERS:
- Mixing valve, pressure balanced, lever handle, preplumbed tee to supply elbow
 - Curtain and rod
 - Caulkless drain
 - Grab bar
 - Soap dish

CODES:

- Designed and manufactured in compliance with the following standards and codes:
- A.N.S.I. Z124.2 Standards for Plastic Showers
 - I.P.C. International Plumbing Code
 - U.P.C. Uniform Plumbing Code

NOTICE OF LIMITATION:



www.orcahealthcare.com
Tel: 1-855-566-6722



We reserve the right to make revisions without notice in the design of fixtures or in packaging unless this right has specifically been waived at the time the order is accepted.

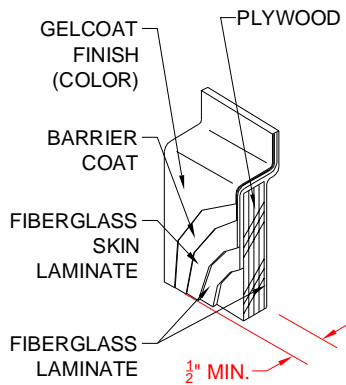

DETAIL B - SCALE: 3" = 1'-0"
WALL SECTION DETAIL

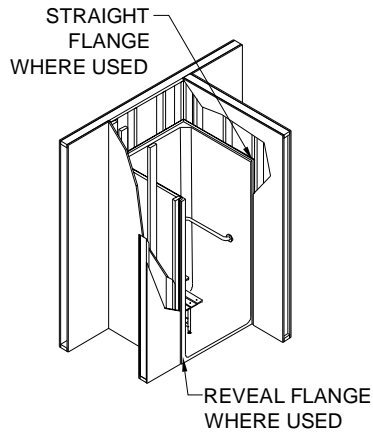

DETAIL C - SCALE: NTS
TYPICAL FRAMING

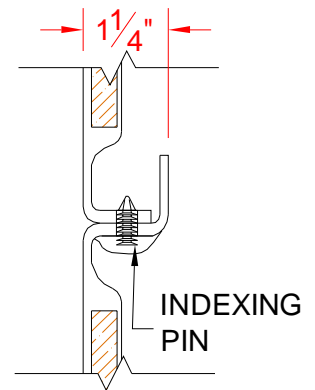

DETAIL D - SCALE: NTS
BACKWALL JOINT DETAIL

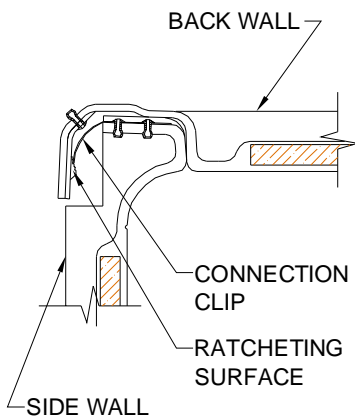

DETAIL E - SCALE: NTS
WALL JOINT DETAIL

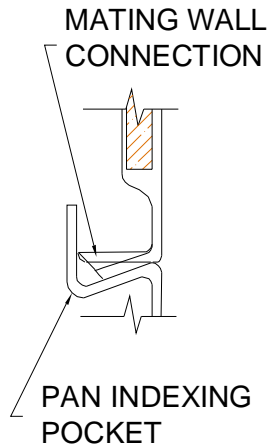

DETAIL F - SCALE: NTS
PAN JOINT DETAIL

